

Imaging of the Building Contours with Through the Wall UWB Radar System

Michal AFTANAS, Miloš DRUTAROVSKÝ

Dept. El. Mmedia Comm., Fac. of El. Engg. and Inform., T. Univ. of Košice, Park Komenského 13, 041 20 Košice, Slovakia

Michal.Aftanas@tuke.sk, Milos.Drutarovsky@tuke.sk

Abstract. *Any actual information about a building interior can be very useful before entering a dangerous area. It can be used to plan strategies in many rescue and security applications. The paper deals with imaging of the inner and outer building contours from the outside using through the wall UWB radar. The whole processing chain for obtaining the contours of a scanned building is explained. The image processing method of highlighting the building walls using Hough transform with assumed knowledge of the direction of walls is presented. The algorithm was tested on real measurement data acquired from a M-sequence UWB radar system.*

Keywords

UWB radar system, through the wall imaging, SAR scanning, Hough transform, highlighting the walls.

1. Introduction

Ultra Wide Band (UWB) electromagnetic waves with frequencies up to 3 GHz are able to penetrate through non-metallic walls with relatively small attenuation. Such an ability can be very widely used for a whole field of rescue and security applications. These techniques are most useful when entering a room is very dangerous. In such situations, any additional information about what is actually inside the room and what the room looks like can be very helpful for making strategies before entering the room. Through the wall imaging with UWB radar can be used e.g. to locate hostages or terrorists and weapons behind the walls, people trapped in a building during fire, persons buried under rubble after an earthquake, border controls for detection of illegal immigrants, cigarettes in trucks, to reconstruct an interior of a room full of smoke during fire, etc.

Through the wall short-range sensing with UWB radar is mostly used for detection of moving objects behind the wall [1], [2]. There even exist several commercial products for this purpose [3], [4]. In such a case, the whole stationary background can be subtracted, which leads to a substantial improvement in the ratio between the investigated ob-

jects and clutter or noise. On the other side, for investigating building contours, the objects of interest are stationary, and therefore the background cannot be subtracted. To obtain more information about the targets, Synthetic Aperture Radar (SAR) scanning has to be performed, where the antenna system is moving [5]. The imaging of stationary objects behind a wall is a big challenge in general [6], [7], [8]. Systematic measurement errors caused by clutter, multiple reflections, and not ideal hardware keep this topic still in the research focus. Imaging of the building interior scanned by an UWB radar from a moving vehicle is presented in [9]. In this paper, we use additional signal processing steps such as precise calibration, deconvolution of antenna impulse responses, compensation of antenna footprint, precise compensation of wave parameters that penetrate through the wall. The main part of the article presents a method of highlighting the wall contours by image processing.

The reconstructed image of the scanned building is mostly full of noise and clutter. Therefore, it is very often hard to interpret for a human. Especially, when one takes into account that such a radar system is used by firemen or police and not by a signal processing expert in the radar field. We present an image processing method, which highlights the examined walls and this way makes the final image much more understandable. For this purpose, the Hough Transform (HT) [10] with assumed knowledge of the direction of walls is used. Almost all of the walls are parallel or perpendicular to each other in one building. Therefore, the wall directions can be usually predicted, just precise positions are unknown.

The proposed algorithm was tested on real data obtained from a building measurement with an M-sequence UWB radar device [11].

2. SAR Scanning

UWB radar transmits a short impulse which is reflected by an object and received back by the radar. Such received reflection in a discrete time n is called an A-scan and the position of the impulse in the discrete time domain corresponds to the position of the object in space. In order to obtain more information about the investigated objects and to narrow antenna flaring beam angle, the SAR scanning is applied.

The basic 2D SAR spatial model is shown in Fig. 1a). A transmitted wave is reflected from the target to all directions uniformly. Because the antenna beam is wide, the signal reflected from the target is received not only when the antenna system is exactly over the target, but in many positions that allow "seeing" the target. This will cause that one point in $S(X, Y)$ space will be represented in an acquired B-scan (set of A-scans assembled together in a 2D structure) as a hyperbola, as shown in Fig. 1b) [12]. The X the is scanning direction and Y is the looking direction.

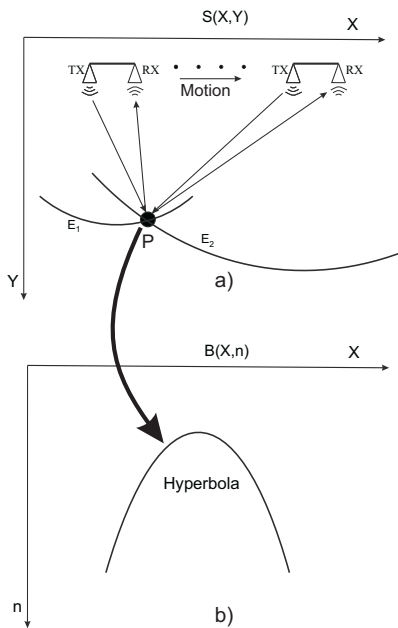

Fig. 1. a) 2D SAR spatial model b) B-scan of one point.

3. Calibration and Preprocessing

Before SAR migration can be applied, several preprocessing and calibration steps have to be undertaken, such as oversampling, time zero estimation, crosstalk removal and deconvolution [12]. This preprocessing is necessary for imaging of objects behind the wall and greatly improves the resulting image. The $B(X, n)$ (Fig. 2a)) is oversampled by the cubic spline interpolation with an oversampling factor K in the discrete time domain (Fig. 2b)):

$$B_s(X, k) = S_{pline}(B(X, n), K), \quad k = Kn - K + 1 \quad (1)$$

where S_{pline} is a cubic spline function and k is oversampled discrete time. This step does not improve hardware resolution of the radar system, but can help to find crosstalk and time zero more precisely and can slightly improve the image after SAR imaging. Time zero $\tau(k)$ is the time instant in which the transmitted signal leaves the transmit antenna. $B_s(X, k)$ has to be shifted, so that the $\tau(k)$ is at the beginning of the dataset (Fig. 2c)). Crosstalk $C(k)$ is the signal which is transmitted directly from the transmit antenna to the receive antenna. It does not contain any information about the

scanned object, but mostly represents the biggest part of the received signal. Therefore, it should be measured in free space, oversampled analogically to (1), and removed from all the impulse responses. The whole system, and mostly the antennas, have their own impulse responses $h_s(k)$, which significantly affects the received signal. To reduce this influence, the $B_s(X, k)$ are deconvolved with the impulse response of the whole radar system $h_s(k)$, including the antennas. Crosstalk can be measured in an anechoic chamber room or in a free space against a big metal plate and oversampled analogically to the (1).

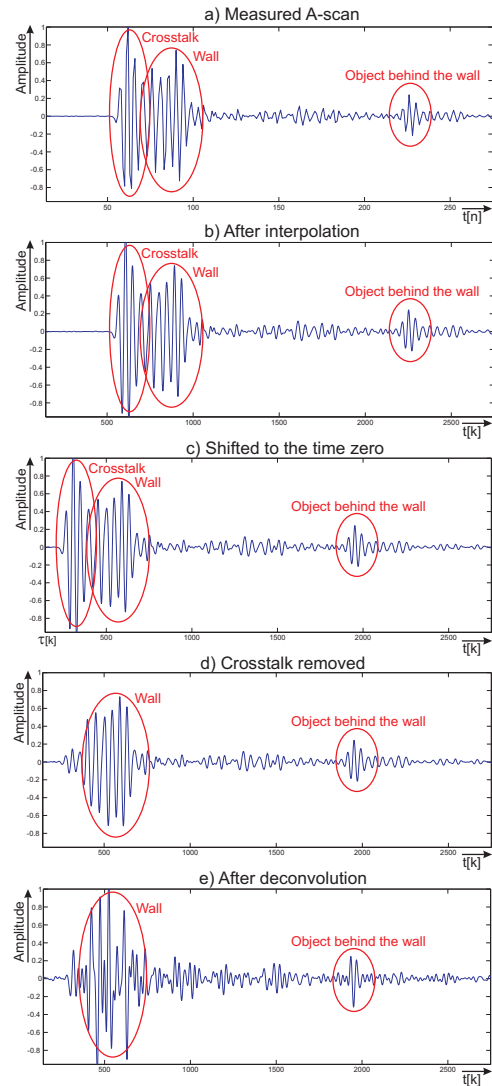

Fig. 2. Calibration and preprocessing steps.

The interpolated and shifted signal with removed crosstalk after deconvolution $P(X, k)$ can be expressed as:

$$P(X, k) = \{B_s(X, k - \tau(k)) - C(k - \tau(k))\} * h_s^{-1}(k) \quad (2)$$

where $h_s^{-1}(k)$ is the inverse impulse response of the whole radar system.

4. Through the Wall Imaging Algorithm

After SAR scanning, calibration and preprocessing, the $P(X, k)$ is obtained. In order to transform $P(X, k)$ back to the $S(X, Y)$ space, a migration algorithm has to be used. The signal received in a given time can be reflected from all the points that lie on the locations where Time Of Arrival (TOA) is constant. The points that have the same TOA lie on a hyperbola with foci at the transmitter and receiver positions. The migration geometrically focuses hyperbolas from $P(X, k)$ into one point in $S(X, Y)$.

There are several migration algorithms which can be used to image objects behind walls [13]. The simplest imaging method is 2-dimensional SAR migration in the time domain [12]. It is a migration with a simple geometrical approach often called back projection [14] or diffraction summation [5], and it does not take into account the wave equation. This method is simple to implement, easy to modify, but requires big computing power. A similar approach is used in the so called Kirchhoff Migration [15]. It is based on solution of a scalar wave equation. Partial differential equations called separation of variables based on Green's theorem are used. Kirchhoff migration theory provides a detailed prescription for computing of the amplitude and phase along the wavefront in variable velocity, and the shape of the wavefront. The Kirchhoff theory shows that the summation along the hyperbola must be done with specific weights and for variable velocity. Then, the hyperbola is replaced by a more general shape. Kirchhoff migration is mathematically a complicated algorithm and can be found described in depth in [13] and [15]. Wave equation based migration can also be done in the frequency domain. Stolt showed that the migration problem can be solved by the Fourier transform [16]. Such a process is called f-k migration, or Stolt migration. This method is very fast with low computational complexity, but it is not so easy to be modified for additional improvements.

The estimation of the object distribution in an arbitrary point $I(X, Y)$ by a simple 2-dimensional SAR migration is computed by:

$$I(X, Y) = \frac{1}{N} \sum_{i=1}^N P(X, k = TOA_i) \tag{3}$$

where N is the number of antenna positions and TOA_i is the travel time of the signal from transmit antenna to the point $I(X, Y)$ and back to the receive antenna.

The wave that penetrates through the wall is attenuated, part of its energy is reflected and diffracted. The velocity of the wave propagation inside the wall is reduced. As shown in Fig. 3, the TOA cannot be computed as a straight line between the transmit antenna, the object and the receive antenna. There are several methods of how to compensate this effect. For our experiment, we used a precise, efficient and fast method of TOA estimation, that the authors described

in [17]. The wave penetrating through the wall is much more attenuated in the wall than in the air, especially in a thick wall with high conductivity.

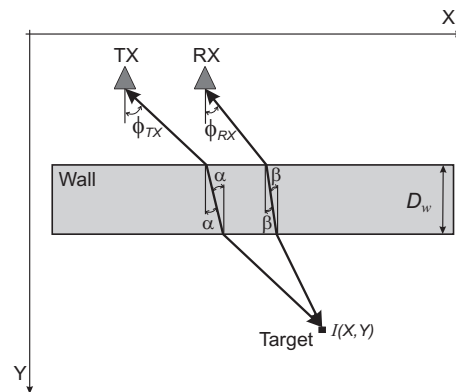

Fig. 3. Model of a wave penetrating through the wall.

The magnitude of the wave behind the wall is given by [18]:

$$att = a_0 e^{-2D_w \left(2\pi f \sqrt{\frac{\mu_w \epsilon_w}{2} \left[\sqrt{1 + \left(\frac{\sigma_w}{2\pi f \epsilon_w} \right)^2} - 1 \right]} \right)} \tag{4}$$

where a_0 is the magnitude of the wave in front of the wall, att is the magnitude of the wave behind the wall, D_w is the wall thickness, f is the wave frequency, μ_w is the permeability of the wall, ϵ_w is the permittivity of the wall, and σ_w is the conductivity of the wall. The $P(X, k)$ is weighted by att for all the points $I(X, Y)$ that are behind the wall in order to compensate the wall attenuation. The spread losses in the air are compensated by a simple reciprocal proportion.

The antenna directional properties cause that the waves transmitted or received aslant to the antennas (under the angles (ϕ_{TX}) and (ϕ_{RX})) have lower amplitudes. The footprint function of the transmit antenna $W_{TX}(\phi_{TX})$ and receive antenna $W_{RX}(\phi_{RX})$ (see Fig. 3) can be measured by rotating the antennas in an anechoic chamber room. The $P(X, k)$ is then weighted by the antenna footprint before the summation:

$$I_w(X, Y) = \frac{1}{N} \sum_{i=1}^N att W_{TX} W_{RX} P(X, k = TOA_i). \tag{5}$$

5. Image Processing for Wall Highlighting

The walls that represent the building contours are mostly distorted by clutters and noise in the processed image $I_w(X, Y)$. We are looking for big straight walls, with good reflections, that represent building contours. To highlight such walls we propose the following image processing steps: The image $I_w(X, Y)$ is transformed to the gray-level. The edges are found with the edge detector so the picture is converted

to the binary image $I_{wDE}(X, Y)$. The Hough transform is applied. The peaks in Hough space are filtered according to the wall direction assumptions and lines which represent the investigated walls are drawn back to the $I_w(X, Y)$ image.

Canny edge detector [19] was used to detect the edges, as it is very often used for detection of lines in combination with HT in SAR images obtained by an aircraft [20] or for ground penetrating radar SAR scans [21]. The combination of HT and SAR images obtained by aircraft or satellite was also used to find buildings in maps [22].

The HT is used to find the lines in the image:

$$I_{HT} = HT(I_{wDE}(X, Y)). \quad (6)$$

HT is a feature extraction technique used in image analysis, computer vision, and digital image processing [23], [10]. The HT is mostly used for finding straight lines (or a certain class of shapes) hidden in larger amounts of other data. The main advantage of the HT technique is that it is tolerant to gaps in feature boundary descriptions and is relatively unaffected by image noise [24]. The motivating idea behind the Hough technique for line detection is that each input point in the image indicates its contribution to a globally consistent solution (e.g. the physical line which gave rise to that image point). A line segment can be described analytically in a number of forms. However, a convenient equation for describing a set of lines uses parametric or normal notion [24]:

$$x \cos(\theta) + y \sin(\theta) = r \quad (7)$$

where r is the distance from the origin to the line along the vector perpendicular to the line. θ is the angle of the perpendicular projection from the origin to the line measured in radians clockwise from the positive X-axis (see Fig. 4). The range of theta is $-\pi/2 \leq \theta < \pi/2$. The angle of the line itself is $\theta + \pi/2$, also measured clockwise with respect to the positive X-axis. The possible plotted (r, θ) values defined by each (x, y) map points in the cartesian image space to curves (i.e. sinusoids) in the polar Hough parameter space. This point-to-curve transformation is the HT for straight lines. Resulting peaks in the Hough space represent the corresponding straight line in the investigated image [24].

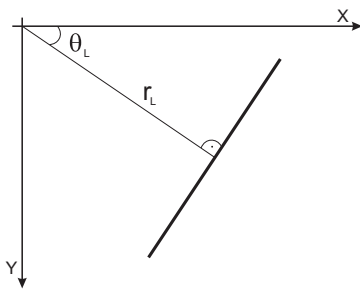

Fig. 4. Parametric description of a straight line.

The points (x, y) representing the line in Fig. 4 are transformed in Hough space into the number of sinusoids shown in Fig. 5.

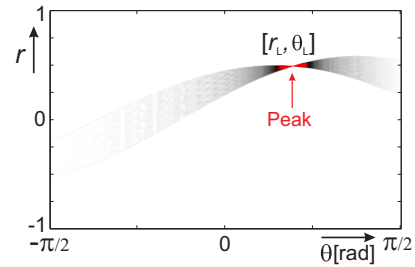

Fig. 5. Hough transform of a straight line from Fig. 4.

As can be seen, the maximum of summed sinusoids represents a peak at (r_L, θ_L) position corresponding to the line in (X, Y) space. The longer the lines, the higher the peaks will be. Lower peaks are considered to be shorter lines and thus are not interesting for our purpose, because we are looking for long and straight walls.

The main idea of the paper is to use the assumed information about the wall directions, which will greatly reduce falsely detected lines. Almost all buildings have all walls parallel, or perpendicular to the main outer walls. This means, that almost all of the walls are perpendicular or parallel to each other in one building. The radar scan is done alongside the one (or more) outer wall(s), as it is shown in Fig. 6a). Therefore, there is a high probability that peaks in Hough space representing the scanned walls will be approximately at the positions where the wall angle is equal to:

$$\theta_w = 0 \text{ and } \pm \pi/2. \quad (8)$$

as shown in Fig. 6b).

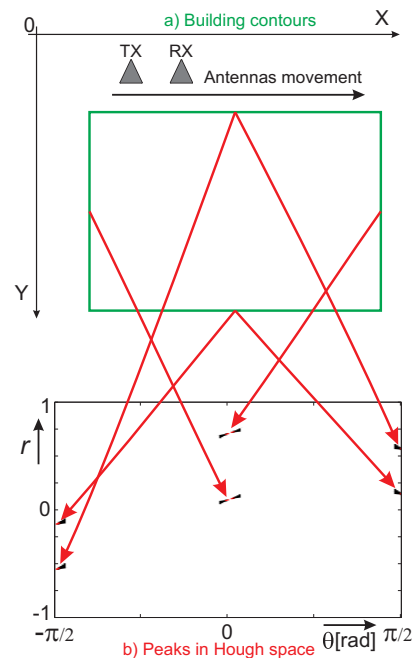

Fig. 6. Hough transform of the building contours. a) The building contours scanned with UWB radar. b) The peaks in Hough space of the scanned image.

The easiest way to reduce all of the lines that are not perpendicular or parallel to the wall along which the scan is done is to clear all points in Hough space, that are not

close to the θ_w . For that purpose, sharp window functions with peaks at θ_w are used. The peaks found in Hough space are then transformed by the Inverse Hough Transform (IHT) back to the (X, Y) space as a certain number of straight lines. These lines can be drawn over the original image, so the wall can be found much easier.

The sequence of processing steps from SAR scanning to obtain the final image with the detected building contours is shown in Fig. 7.

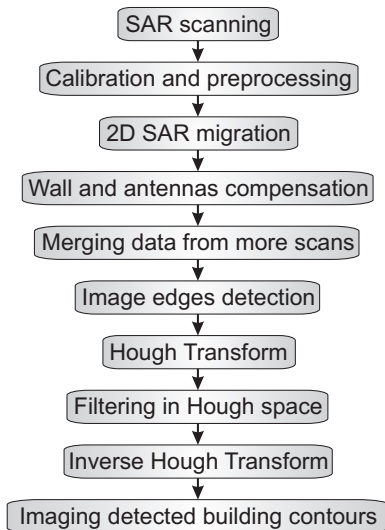

Fig. 7. Processing steps for imaging of building contours.

6. Measurement Device and Scenario

For testing of the proposed algorithm, the UWB Maximum Length Binary Sequence (M-sequence) radar system [11], [25] with frequency band DC – 2.25 GHz was used. The first idea to use a very well known M-sequence in UWB radar was proposed in 1996 by Jürgen Sachs and Peter Pey-erl, US patent No. 6272441 [11]. The main advantages of using M-sequence UWB radar in comparison with classical pulse, or continuous wave radar [26] are: the use of periodic signals avoids bias errors, it allows linear averaging for noise suppression, M-sequence has a low crest factor which allows to use the limited dynamics of real systems and the signal acquisition may be carried out by undersampling. These signals with an extreme bandwidth may be sampled by using low cost, commercial Analog to Digital Converters (ADC) in combination with sampling gates.

The block diagram of the used M-sequence UWB radar system is shown in Fig. 8. The N-stage shift register generates the M-sequence which is transmitted via the transmit antenna. An electromagnetic wave is reflected from targets and received via receive antennas. The received M-sequence is undersampled, averaged, and correlated with the transmitted one. The time shift between them corresponds to the distance between transmitter, target and receiver. In principle, after the correlation, the output from the M-sequence radar

system is the same as the output from a classic pulse radar system. Therefore, the common preprocessing and imaging algorithms can be used.

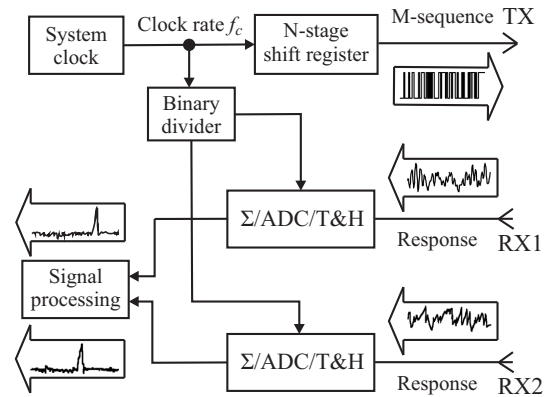

Fig. 8. Block diagram of M-sequence UWB radar system.

The wooden building shown in Fig. 9a) was scanned from 3 sides. A bistatic model and the horn antennas with frequency band 0.3 – 3 GHz were used. After interpolation with oversampling factor $K = 10$, calibration, preprocessing, 2D SAR migration in time domain [12], the wall effect [17] and the antenna beam were compensated as described above for all the scans. The migrated images from three scans were merged together (Fig. 9b)) and edges were detected (Fig. 9c)). The HT was applied (Fig. 9d)) and the peaks at positions close to the θ_w were filtered with a sharp window function (Fig. 9e)). The lines that represent the building walls were drawn over the migrated image after the IHT was performed (Fig. 9f)).

It is obvious that the migrated image (Fig. 9b)) without additional image processing is very hard to interpret. The detected walls drawn in red (Fig. 9f)) help to highlight the contours of a scanned building.

7. Conclusion

In this paper, the complete process for imaging of the inner and outer building contours from the outside with a through the wall UWB radar system is presented. The calibration, preprocessing and migration techniques with additional improvements were used. The Hough transform with assumed knowledge about wall directions was used for highlighting of the building contours. The proposed algorithm was tested on real measurement data where the building was scanned from three sides. The contour of the building was scanned from the outside, so there is no need to enter the dangerous area before a good tactic is created. The proposed scanning can be used for rescue and security applications. In the future work, an algorithm will be tested which would enable to highlight the shorter walls, that are not crossing all the image. Also, the antenna polarization and radar hardware improvement will be further investigated.

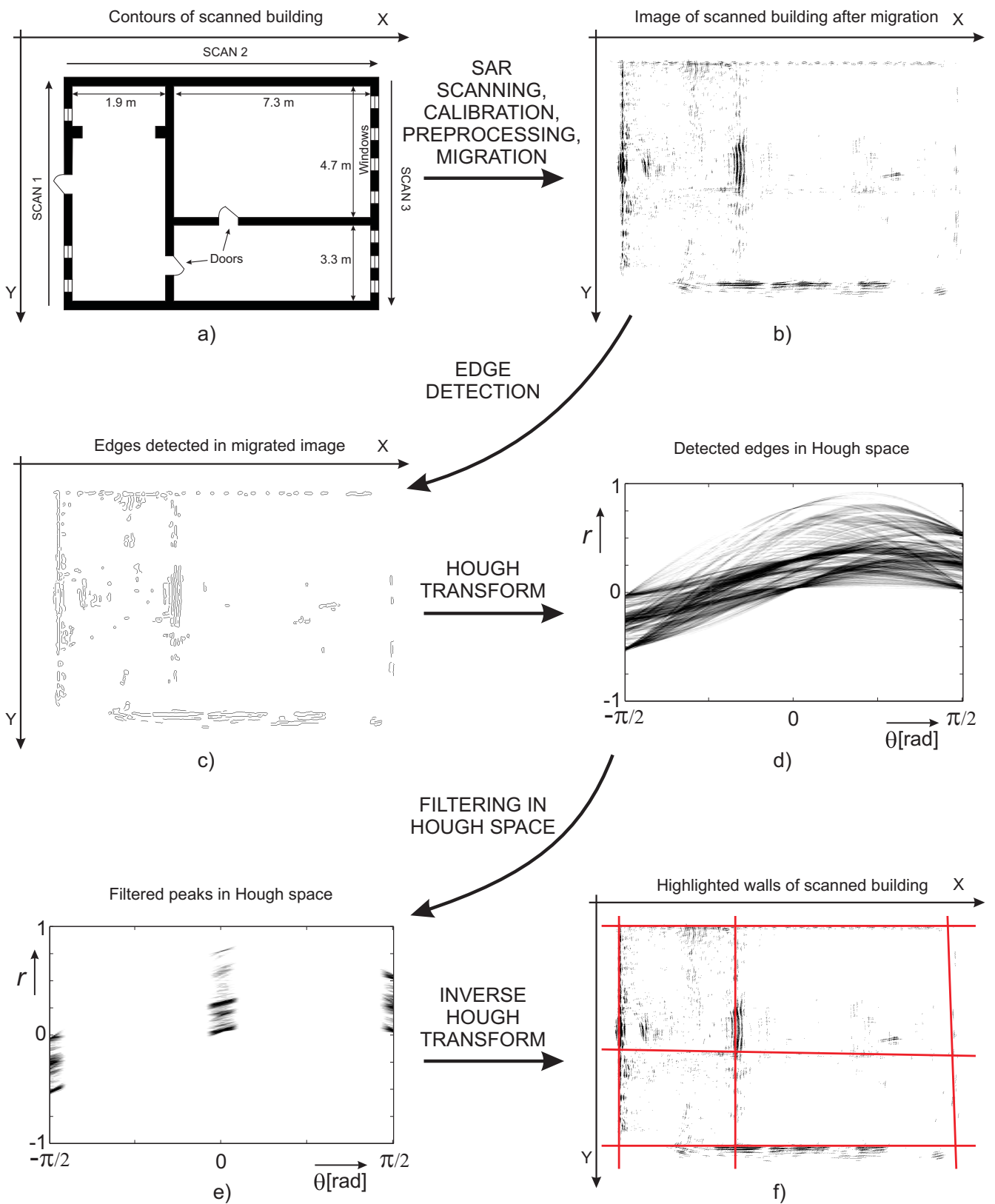

Fig. 9. Steps of highlighting the building walls in the scanned image: a) The real contours of the scanned building. b) The image of the scanned building merged from three scans. c) The edges detected in the image b) by Canny detector. d) The Hough Transform performed on the detected edges. e) The peaks in Hough space filtered by a sharp window function. f) The highlighted walls drawn over the scanned image obtained by Inverse Hough Transform.

Acknowledgements

This work was supported by the European Commission through the 6th framework under the contract COOP-CT-2006-032744 RADIOTECH, the Slovak Research and Development Agency under the contract No. LPP-0287-06 and by the DAAD scholarship.

References

- [1] SACHS, J., AFTANAS, M., CRABBE, S., DRUTAROVSKY, M., KLUKAS, R., KOCUR, D., NGUYEN, T. T., PEYERL, P., ROVNAKOVA, J., ZAIKOV, E. Detection and tracking of moving or trapped people hidden by obstacles using ultra-wideband pseudo-noise radar. In *European Radar Conference EuRAD 2008*, Amsterdam (The Netherlands), 2008, p. 408 - 411.
- [2] BURCHETT, H. Advances in through wall radar for search, rescue and security applications. In *Conference on Crime and Security. The Institution of Engineering and Technology*, London (UK), 2006, p. 511 - 525.
- [3] Endoacustica. Prisma - Through Wall Radar, multiple persons location. [Online]. Available: http://www.endoacustica.com/details-prisma_en.htm.
- [4] Camero. XaverTM800 - Through Wall Vision, one and two persons. [Online]. Available: <http://www.camero-tech.com/xaver800.shtml>.
- [5] MILLER, D., ORISTAGLIO, M., BEYLKIN, G. A new slant on seismic imaging. *Migration and Integral Geometry: Geophysics*, 1987, vol. 52, p. 943 - 964.
- [6] GAUTHIER, S., HUNG, E., CHAMMA, W. Surveillance through concrete walls. *Sensors and Command, Control, Communications, and Intelligence*, 2004, vol. 5403, p. 597 - 608.
- [7] NGUYEN, L., CALVIN, L., GUILLERMO, C. G. Computerized tomographic radar target imaging behind opaque walls. *Opt. Eng. Remote Sensing*, 2007, vol. 46.
- [8] BORYSSENKO, A. O. et al. UWB Subsurface radar with antenna array for imaging of internal structure of concrete structural elements. *Ultra-Wideband, Short-Pulse Electromagnetics 5*, Springer US, 2002, p. 199 - 206.
- [9] DORAGU, T., LE, C. Ultra-wideband radar for building interior imaging. In *Army Science Conference*, 2008, vol. 26.
- [10] DUDA, R. O., HART, P. E. Use of the Hough transformation to detect lines and curves in pictures. *Commun. ACM*, 1972, vol. 15, p. 11 - 15.
- [11] DANIELS, D. *M-sequence Radar. In Ground Penetrating Radar*. 2nd ed. Peter Peregrinus Ltd, 2004.
- [12] AFTANAS, M. Through wall imaging using Msequence UWB radar system. *Thesis to the dissertation examination*, Technical University of Kosice, Department of Electronics and Multimedia Communications, Slovak Republic, Dec. 2007, p. 63.
- [13] MARGRAVE, G. F. *Numerical Methods of Exploration Seismology with Algorithms in Matlab*. Master's thesis, Department of Geology and Geophysics, University of Calgary, 2001, p. 160.
- [14] ULANDER, L., HELSTEN, H., STENSTROM, G. Synthetic aperture radar processing using fast factorized backprojection. *Aerospace and Electronic Systems*, 2003, vol. 39, p. 760 - 776.
- [15] YILMAZ, O. *Seismic Data Processing (Investigations in Geophysics, Vol 2)*. Society of Exploration, 1987.
- [16] STOLT, R. H. Migration by Fourier transform. *Geophysics*, 1987, vol. 43, p. 23 - 48.
- [17] AFTANAS, M., ROVNAKOVA, J., DRUTAROVSKY, M., KOCUR, D. Efficient method of TOA estimation for throughwall imaging by UWB radar. In *IEEE International Conference on Ultra-Wideband (ICUWB2008)*, Hannover (Germany), 2008, vol. 10, p. 101 - 104.
- [18] KHATRI, H., LE, C. Identification of electromagnetic parameters of a wall and determination of radar signal level behind a wall. In *Proceedings of SPIE, the International Society for Optical Engineering*, Florida (USA), 2006, vol. 6210.
- [19] CANNY, J. A computational approach to edge detection. *IEEE Transactions on Pattern Analysis and Machine Intelligence*, 1986, vol. 8, p. 679 - 698.
- [20] CHENG-LI, J., KE-FENG, J., YONG-MEI, J., GANG-YAO, K. Road extraction from high-resolution SAR imagery using Hough transform. *IEEE International Geoscience and Remote Sensing Symposium*, Changsha (China), 2005, vol. 1, p. 336 - 339.
- [21] KABAKCHIEV, CH. et al. *UXO Signal Multi Sensor Detection and Estimation, in Unexploded Ordnance Detection and Mitigation*. Springer, 2008.
- [22] XU, F., JIN, Y. Automatic reconstruction of building objects from multiaspect meter-resolution SAR images. *IEEE Transactions on Geoscience and Remote Sensing*, 2007, vol. 45, p. 2336 - 2353.
- [23] TURAN, J., FARKAS, P. Line fitting using Hough-like procedure. *Radioengineering*, 2001, vol. 10, no. 1, p. 25 - 30.
- [24] FISHER, R., PERKINS, S., WALKER, A., WOLFART, E. *Hypermedia Image Processing Reference*. October 2000, [online] available at: <http://homepages.inf.ed.ac.uk/rbf/HIPR2/>.
- [25] SACHS, J., PEYERL, P., WOCKEL, S., KMEC, M., HERRMAN, R., ZETIK, R. Liquid and moisture sensing by ultra-wideband pseudo-noise sequence signals. *Measurement Science and Technology*, 2007, vol. 18, p. 1074 - 1087.
- [26] IMMOREEV, I., FEDOTOV, P. Ultra wideband radar systems: advantages and disadvantages. In *IEEE Conference on Ultra Wideband Systems and Technologies*, 2002, p. 201 - 205.

About Authors...

Michal AFTANAS was born in 1983 in Stará Ľubovňa, Slovak Republic. He received his M.Sc. degree in electronics and telecommunications in 2006 after defending his Master's Thesis - FSK signal processing based on software defined radio. Currently he is a PhD student at the Department of Electronics and Multimedia Communications, Technical University of Košice and his main research areas are through the wall imaging of objects behind walls with UWB radar systems.

Miloš DRUTAROVSKÝ was born in 1965 in Prešov, Slovak Republic. He received the M.Sc. degree in radioelectronics and PhD degree in electronics from Technical University of Košice, Slovak Republic, in 1988 and 1995, respectively. He defended his habilitation work - Digital Signal Processors in Digital Signal Processing in 2000. He is currently working as an Associated Professor at the Department of Electronics and Multimedia Communications, Technical University of Košice. His current research interests include applied cryptography, sensor networks, applied digital signal processing, and algorithms for embedded cryptographic architectures.